



# HYBRID DOORS



**Homeeefe**  
DOORS • WINDOWS • FLOORING





# Hybrid doors

**HYBRID DOORS IDEA IS BASED ON SMART COMBINATION OF DIFFERENT MATERIALS, TO USE THEIR ADVANTEGES.**

We use range of materials to manufacture external doors such as aluminum, wood, new generation ABS reinforced with fibre glass, veneered steel sheets, stainless steel and high density polyurethane foam.

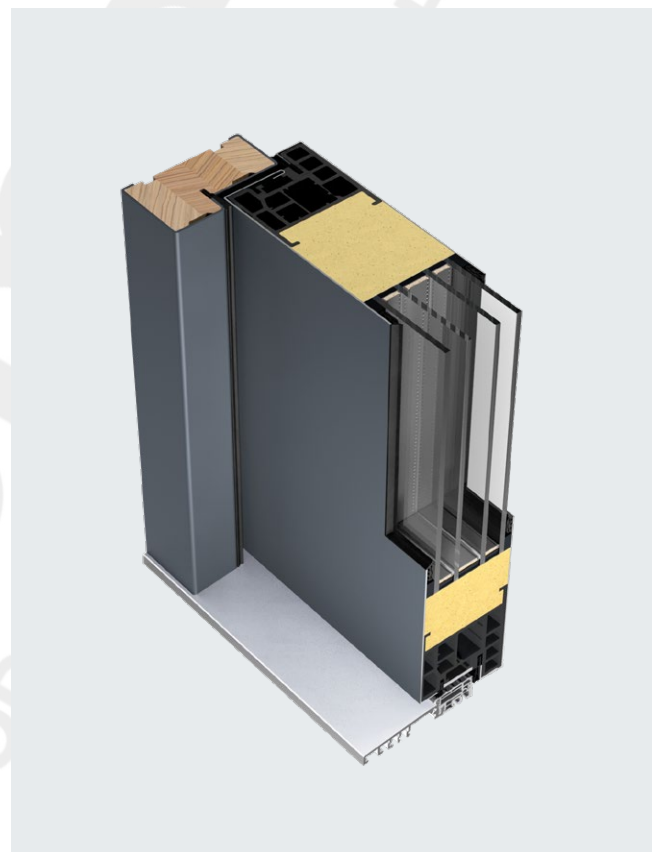
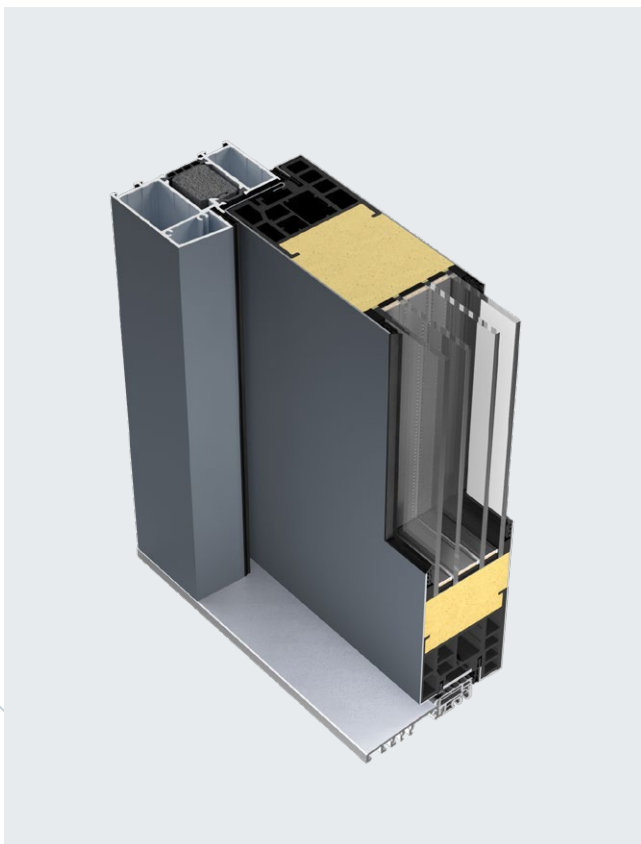

## WHY HYBRID DOORS?

A very big advantage of the hybrid technology, is that the door with excellent parameters and beautiful look, can be offered at an attractive price.

# Unique design

In the case of our Hybrid door, the term “unique design” is not an advertising cliché. Cooperation with best design studios resulted in the creation of four door collections, which designs are truly unique.



# Bespoke made doors

The philosophy of our company focuses on the maximum matching the product to the customer's needs. We do not keep ready doors in stock each project is treated individually. Customers can choose products with different parameters and functionalities. Biggest possibilities of personalization apply to design - the offer is very wide suits different tastes.



# One model – countless arrangements

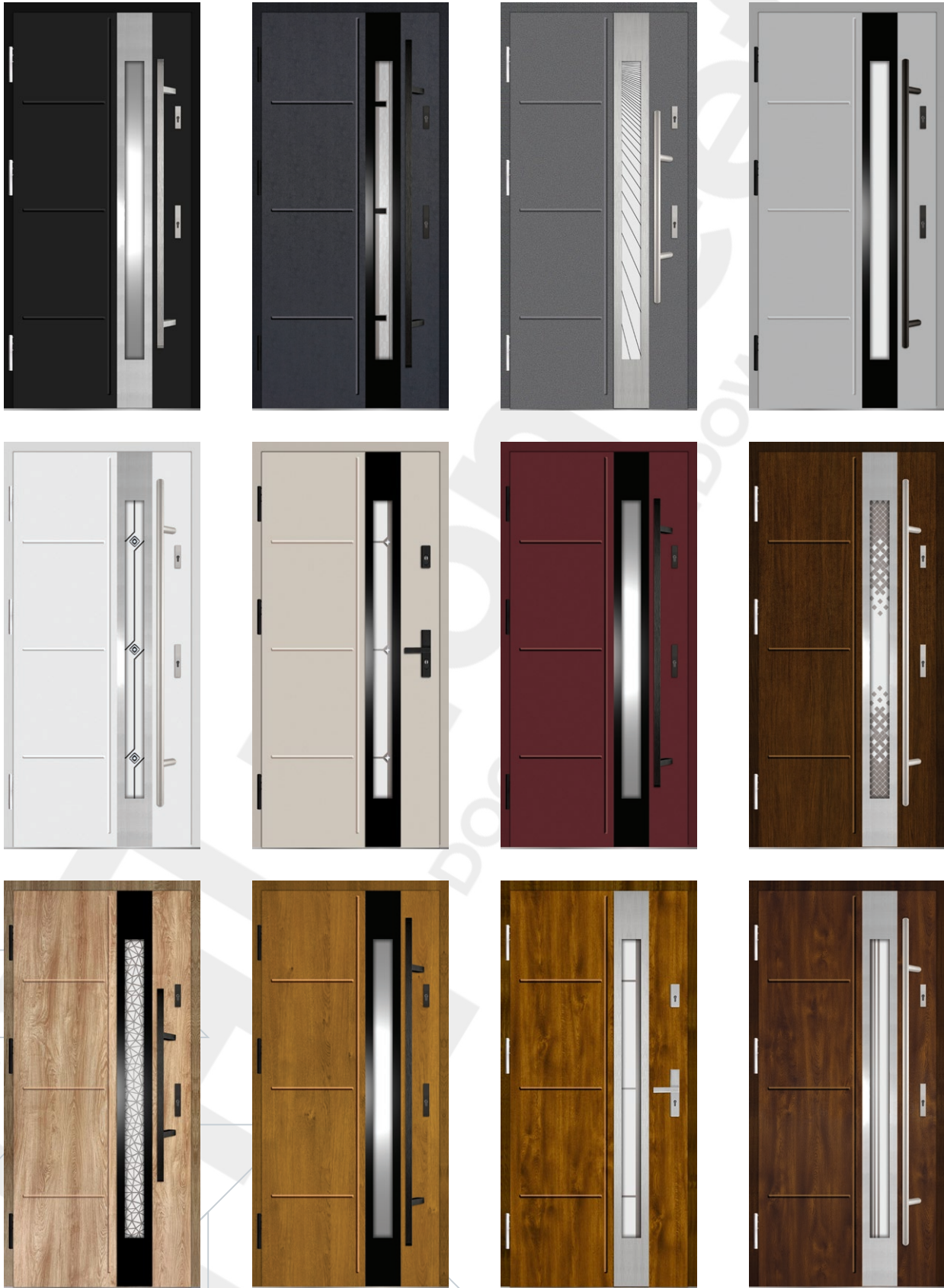



# The door lock is a key to comfort and safety

## ROTO QB MULTI STRIP LOCK – PREMIUM COMFORT AND SAFETY

The strip lock from the reputable German brand ROTO consists of the 4-bolt locks (each pin diameter 12mm) and central lock with a massive bar. One turn of the key causes it to slide out safety. The Roto QB lock is additionally equipped with a unique two-stage mechanism pressure. An additional upper lock can be ordered as an option.

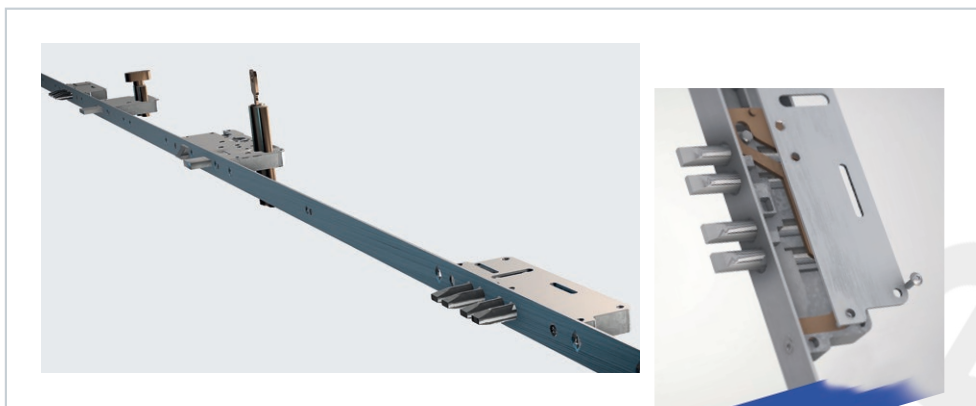

## Warm door frame

We offer two different warm door frames. The standard is wood/steel, but if you like to have a sidelights than we need to upgrade it to aluminium.

### WOOD/STEEL FRAME

Glued wood core provides excellent thermal insulation and stability of the frame. Wood is protected against weather conditions by cladding made of galvanized sheet, veneered identical to the leaf, with a thickness of up to 1.2 mm.

The thick steel section provides rigidity and endurance. The Wood/Steel door frame combines advantages of galvanized veneered steel and wood.

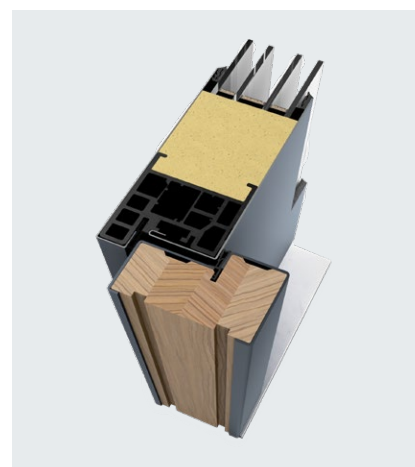

Wood/Steel Frame

### ALUMINIUM FRAME

Aluminum as a construction material has a number of advantages: it is light, resistant to conditions, weatherproof, stiff and durable. Perfect on thermal permeability compared to other solutions achieved thanks to the width of the profile of 72mm. This allowed the use of extra wide thermal inserts. Aluminium door frames have a simple, modern shape. They are veneered same as door leaves.



Arctic Alu

## 3D Hinges – full 3way adjustment

A single 3D Martom hinge carries loads up to 80 kg. Three hinges per sash eliminate the problem of “dropping”. The 3D hinges can be adjusted in three ways-move the sash to the right or left, up, down and push it or move it away from the frame. The slim, modern look of the hinges makes them a great addition to the Hybrid doors.



Door Hinge

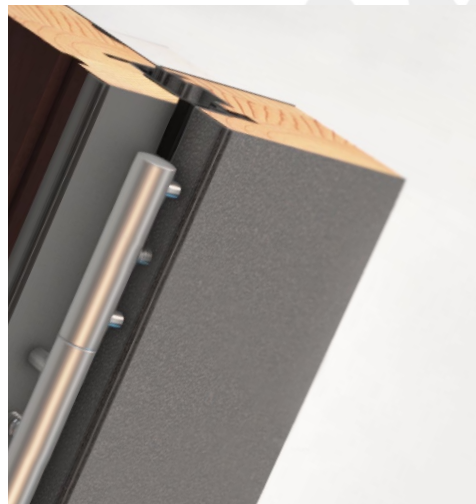

Aluminium covers will add the elegant smooth shape. Also available in black.

## Door core

The leaf core is made of galvanized steel sheet covered with a special veneer similar to uPVC windows or garage doors. Laminate is very durable, resistant to scratches and UV. No maintenance required. Special coating makes the door very easy to maintain clean. Thick steel sheet in combination with PUR foam provides resistance to dents.



## PUR filling

The PUR foam filling is made in the injection technology. Perfect adhesion of the foam to the leaf core and to the glazing unit guarantees exceptional structural rigidity. PUR foam give a very high level of thermal insulation.

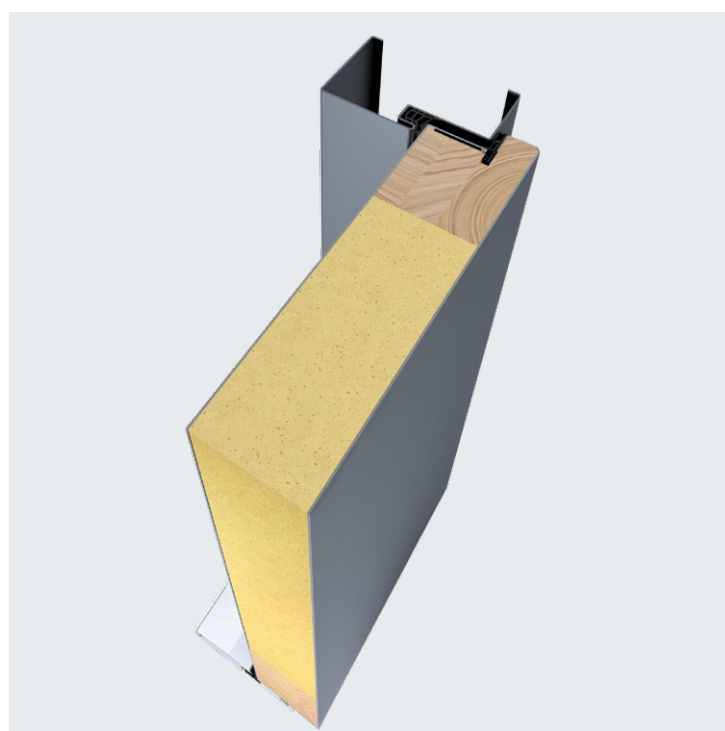

# Hybrid door

72 MM DOOR THICKNESS

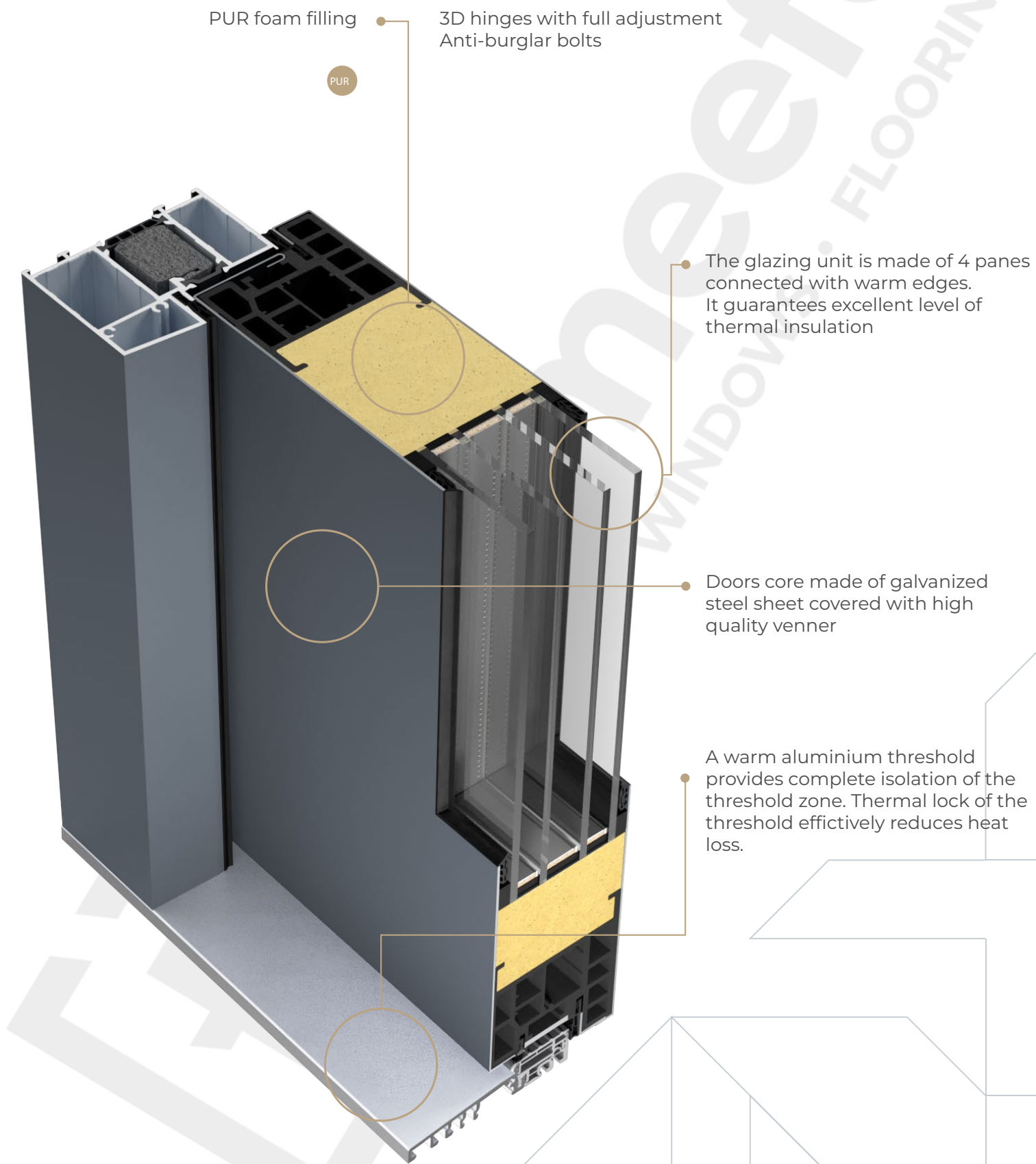



## TABLE OF U-VALUES

	Door Size	Wood/Steel frame	Alu frame
Full door	80	0,92 W/m <sup>2</sup> K	1,00 W/m <sup>2</sup> K
	90	0,88 W/m <sup>2</sup> K	0,96 W/m <sup>2</sup> K
	100	0,84 W/m <sup>2</sup> K	0,90 W/m <sup>2</sup> K

	Door Size	Wood/Steel frame	Alu frame
Glazed door	80	1,10 W/m <sup>2</sup> K	1,10 W/m <sup>2</sup> K
	90	1,00 W/m <sup>2</sup> K	1,10 W/m <sup>2</sup> K
	100	1,00 W/m <sup>2</sup> K	1,00 W/m <sup>2</sup> K

For Hybrid doors there are two variants of the frame available - aluminium and wooden/steel.

Hybrid frames are made in a four-way rebate system, which gives them perfect air tightness.

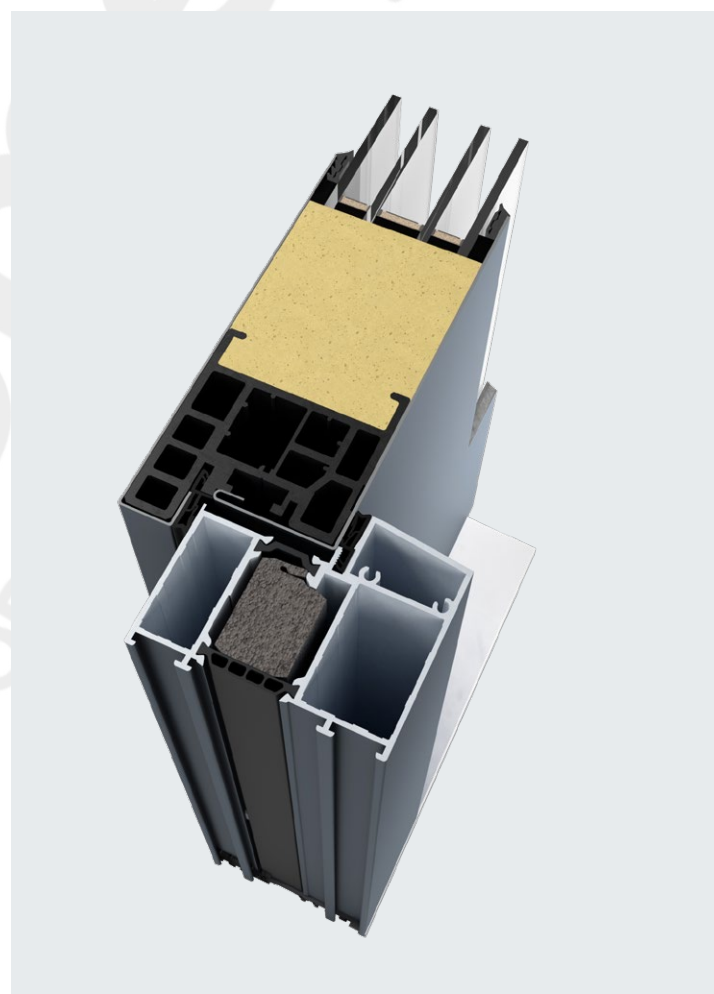
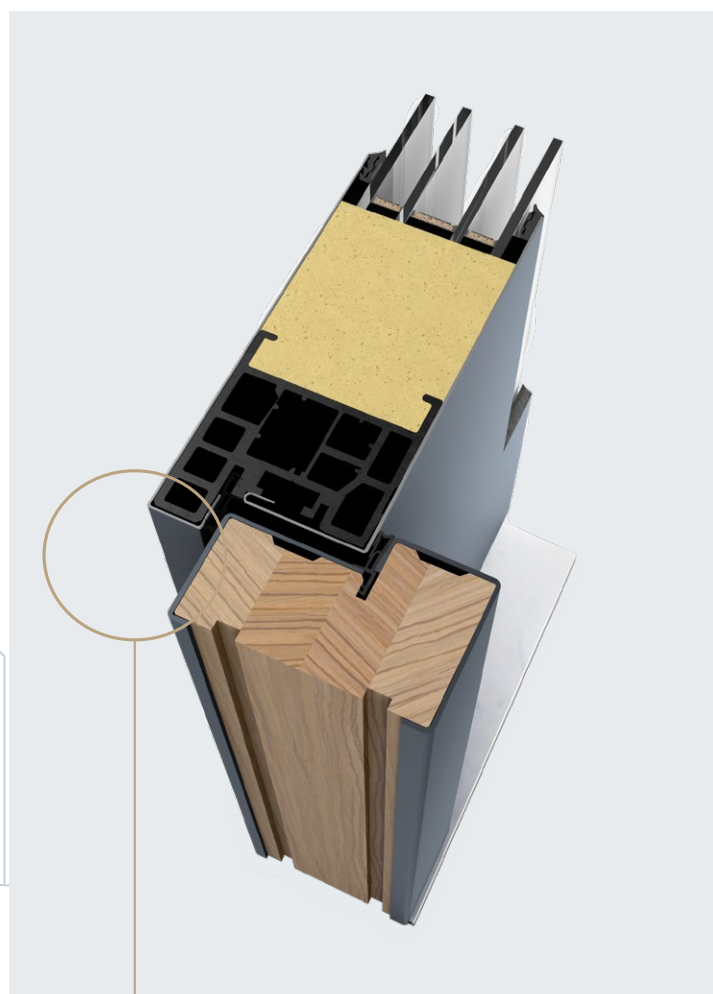

The leaf frame is made of a new generation plastic - ABS reinforced with fibre glass. It guarantees stability of the door, and full air tightness in all weather conditions. Lightweight design prevents the sash from dropping, ensuring smooth operation of the locks. The multi-chamber profile improves thermal insulation.

# Door with sidelights

All door designs can be made with side lights. The catalogue presents examples of models from various collections

## AVAILABLE DOOR SYSTEMS WITH SIDELIGHTS

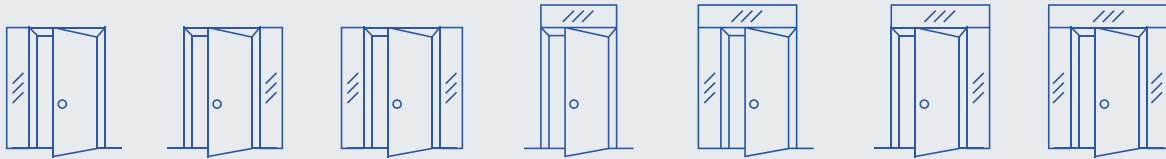

## We offer two types of sidelights



### SIDELIGHT ALU 90 STANDARD

The frame of Alu 90 is made of multi-chamber wide aluminum profile up to 90 mm with a thermal insert. So wide profile is a rarity on the market.



### SIDELIGHT DIAMOND

The frame of Diamond from the outside is covered with a 4 mm thick glass pane with sanded edges. Thanks to covering the frames, the sidelight looks as if it was made entirely of glass.

info

View from inside would be the same for both

## Our own style sidelight - Diamond



Light refracting on the polished edges. Black lacquered frame. Reflections on the glass surface. All this makes the Diamond light suitable for the door and the whole look of an exclusive house. It fits perfectly for facades with stone, ceramic, glass, cladding or decorative concrete.

## Sidelight Alu 90 Standard

### PATTERNS IN GLASS

In addition to standard, fully transparent glazing, Customers can choose, among others, reflex glazing, a mirror, Venetian, sandblasted or milk glass. It is also possible printing any pattern.







## Collection Diamond

A characteristic decorative element in the Diamond collection is lacquered glass with polished edges, placed on the surface of the door leaf. The glare of the reflected light makes the Diamond application a real “jewelry” for the door, giving them a luxurious character. The effect achieved is eye-catching and stylish.

GLASS APPLICATIONS IN THE DIAMOND DOOR COLLECTION AND IN THE DIAMOND LIGHTS ARE MADE WITH THE IDENTICAL TECHNOLOGY AND FOR THAT REASON THEY MATCH EACH OTHER PERFECTLY.



01

#### OUTSIDE OF THE DOOR

4 mm thick glass pane with polished edges. It is the finish of the glazing unit, is attached to the surface of the door.



02

#### INSIDE OF THE DOOR

From the inside glass unit is finished with the aluminium black frame

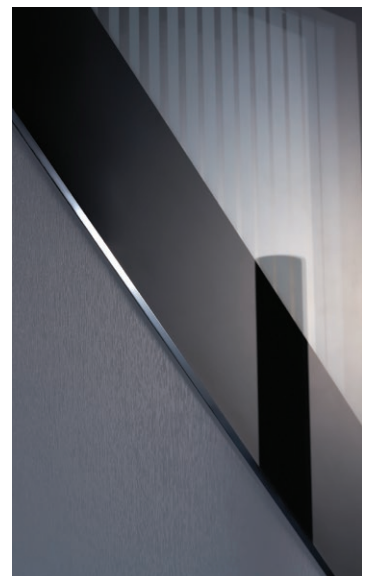





GS 85/61



View from outside



View from inside



Choice of glazing types



GS 86/62

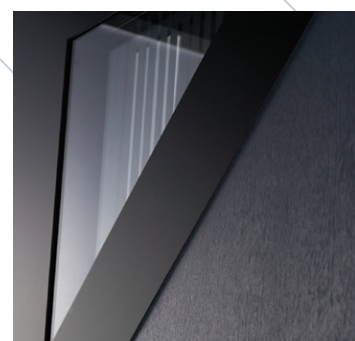



View from outside



GS 87/63 + DIAMOND SIDELIGHT

View from inside

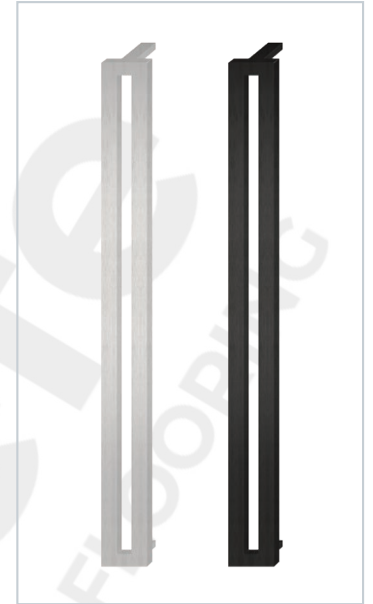

info

Door with Diamond  
sidelight



Handle is made of brushed aluminium.

# Same handle - different door designs



GS 90/63

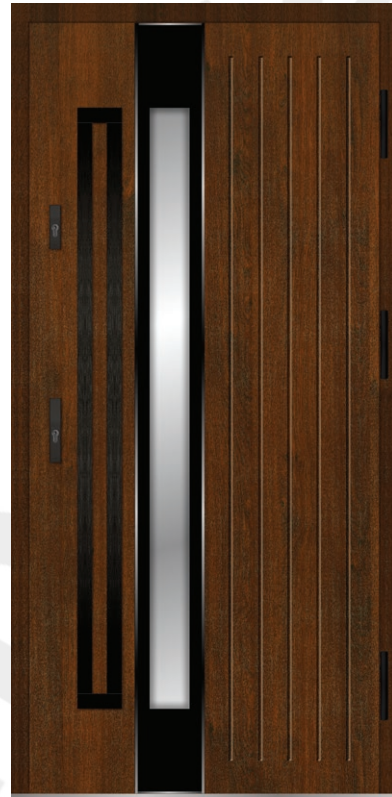

TMS 96/63



TNS 98/65

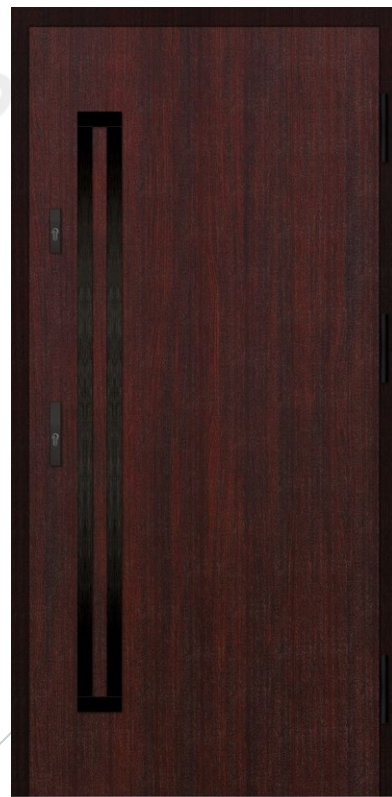

G 00





11S 88/63



GS 88/63



GS 90/63

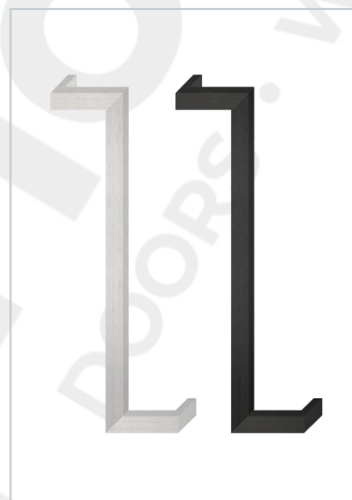





View from outside

View from inside



GS 89/63+ DIAMOND SIDELIGHT





10S 99/66



10S 99/66



GS 99/66



GS 84/60



GS 84/60







GS 101/65



GS 101/65







1JS 89/63



1JS 89/63



1NS 98/65



1MS 96/63



1KS 95/63

View from outside



View from inside

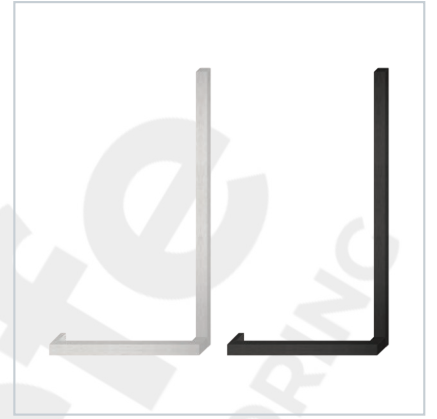

GS 89/63 + DIAMOND SIDELIGHT





View from outside



1LS 97/64

View from inside



1LS 97/64



GS 97/64





LS 17/17



KS 17/17



GS 17/17



GS 18/17



GS 18/17



GS 18/17

## Diamond door 4glass



RS 20/18



GS 20/18

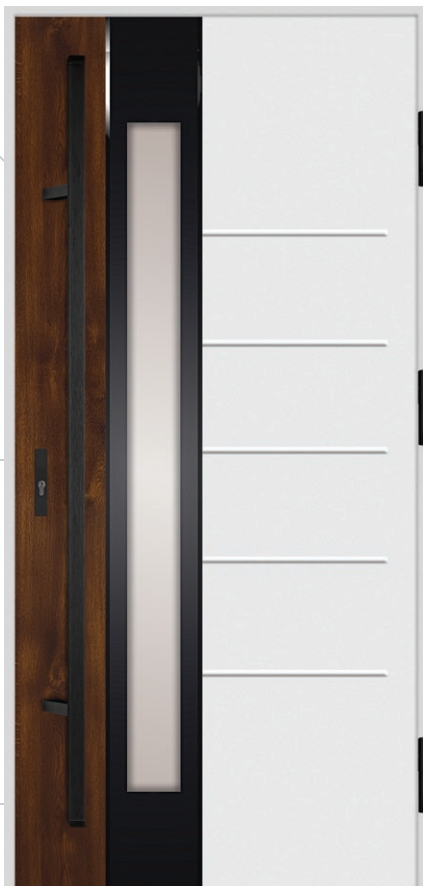

LS 19/17



KS 19/17



GS 19/17

## Diamond door - double colour





# Geometric Collection

The GEOMETRIC door collection refers to the simplicity and geometry known from vintage and industrial styles. Themes made of brushed steel, combined with specially designed handles with the same texture, give the door an interesting, modern character.



View from outside



View from inside



GB 93



The Geometric Fullpers collection has a unique sheet metal application made of anodized aluminum. The surface of the sheet metal looks like this was heavily rubbed with a wire brush the so-called brushed steel effect. The sheet texture is identical to the brushed texture handle.





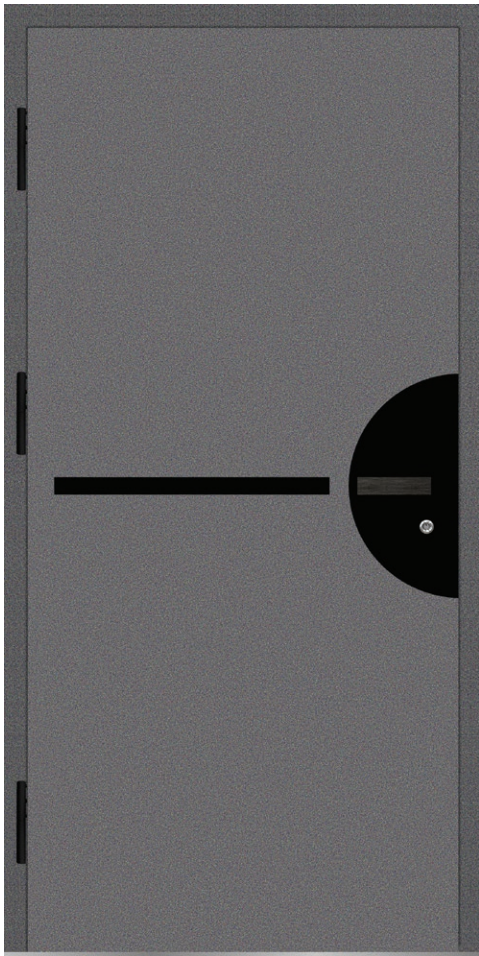

GB 94



GB 100/67

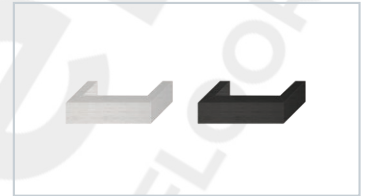

View from outside

View from inside



GB 92 + ALU 90







## Classic Collection

The doors from the Classic collection are characterized by elegant geometry, embossing in the form of lines and rectangles with regular dividing. Thanks to the use of modern technologies, a very interesting combination of tradition and modernity was created in addition to traditional architecture, it can be a very interesting design element also in modern projects. It's worth to pay attention to the possibility of using intense colour.

THE UNIQUE DESIGN OF THE FULLPERS CLASSIC COLLECTION HAS BEEN CREATED THANKS TO THE SPECIALLY DESIGNED ALUMINUM DECORATIVE STRIPS, VENEERED THE SAME AS THE DOOR LEAVES. IN SELECTED MODELS YOU CAN HAVE SOME SUBTLE EMBOSSED.



01

Full elements with decorative frames (cassettes) are recessed relative to the leaf surface in the same way as glazing, giving a three-layer effect. It perfectly emphasizes the intended purpose design effect.



02

It is worth paying attention to the aesthetics of decorative profile connections in the corners. The precisely combined frame is fully applied to the sash. It protects against possible "separation" of the frame profiles in the corners.





# Choose the design and colour



1EK 80/57



1EK 80/57



1EK 80/57



1EK 80/57

View from outside

View from inside



1EK 80/57





View from outside

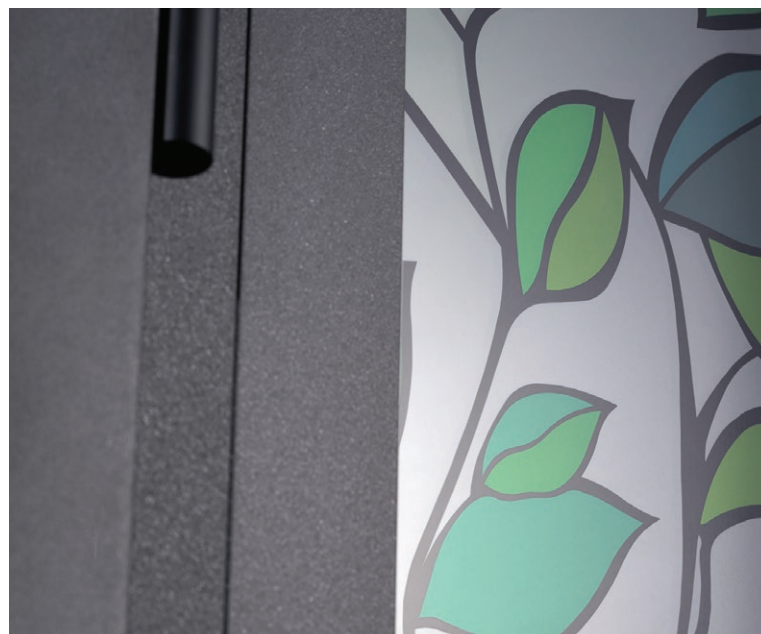

TEK 80 + ALU 90

View from outside

View from inside

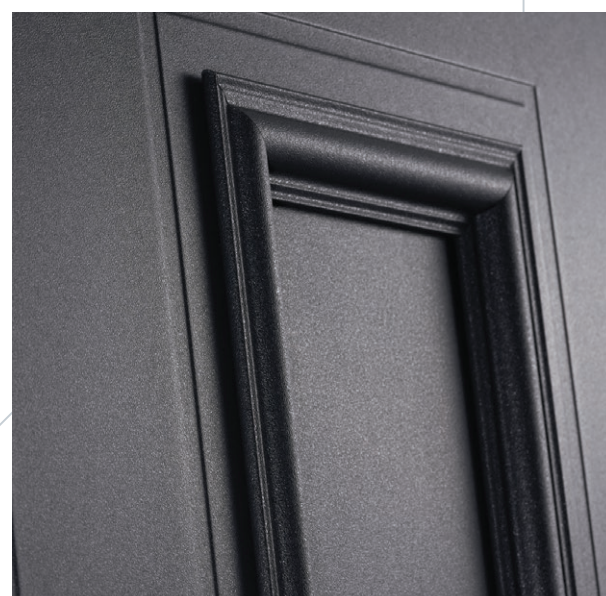

TEK 80



View from outside



View from inside



1FK 81/58





1FK 81



1FK 81/58



1FK 81/58



1HK 83



1HK 83



1HK 83



View from outside

View from inside



IGK 82







1GK 82/59



1GK 82/59



1GK 82/59

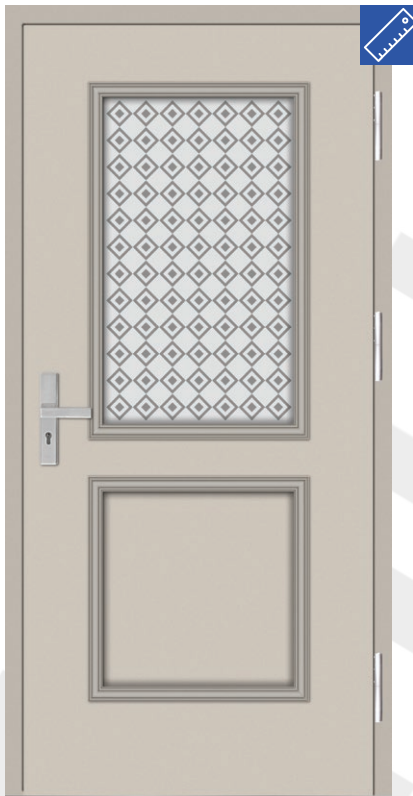

1GK 82/59



1GK 82/59



1GK 82/59





# Simple Elegance Collection

Innovations developed for Hybrid doors allowed to create the unique Simple Elegance collection. As the name suggests, models are characterized by simplicity and elegance, creating a style that is able to adapt to many modern trends.



01



02



03





Q 669/48



U 670/48



X 672/49

View from outside

View from inside



V 671/49





View from outside

View from inside



Y 673/51

Orleefe  
WINDOWS • FLOORING







G 625/49



G 629/49



G 603/48



G 600/48



G 632/51



G 640/52



G 647/53



G 615/49



G 677/49



G 630/49



G 609/49



G 631/49



G 628/49



G 675/49



G 626/49



G 627/49





G 601/48



G 602/48



G 674/48



G 606/48



G 607/48



G 619/48



G 617/48



G 623/48



G 676/48



G 613/48



G 604/48



G 605/48



G 620/48



G 621/48



G 622/48



G 624/48





G 611/50



G 642/52



G 645/52



G 634/51

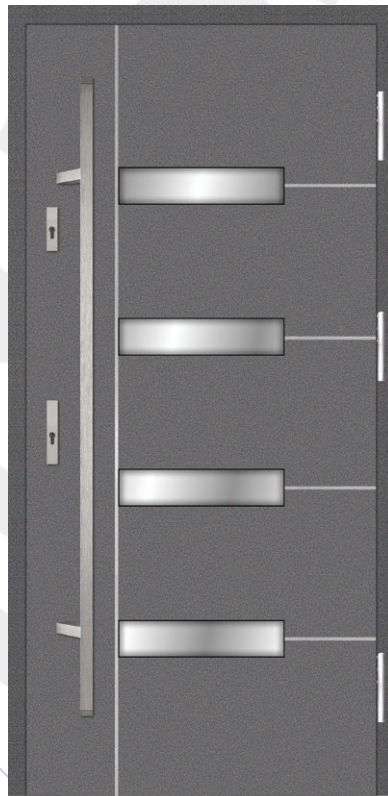

G 637/51

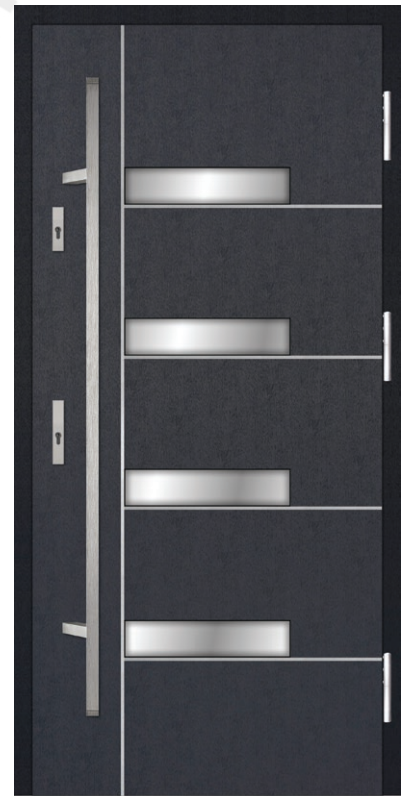

G 638/51

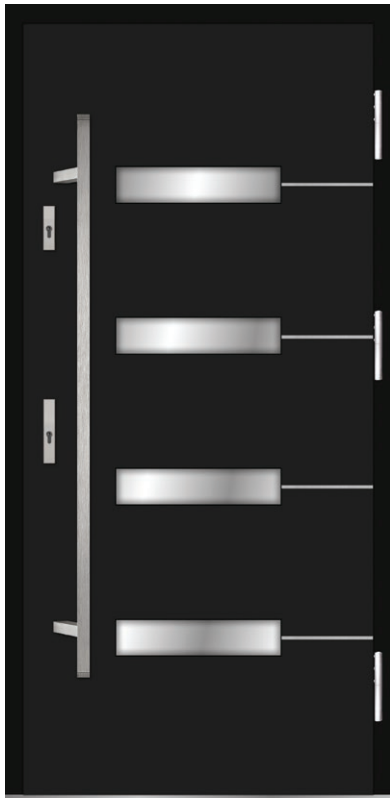

G 636/51



G 651/53

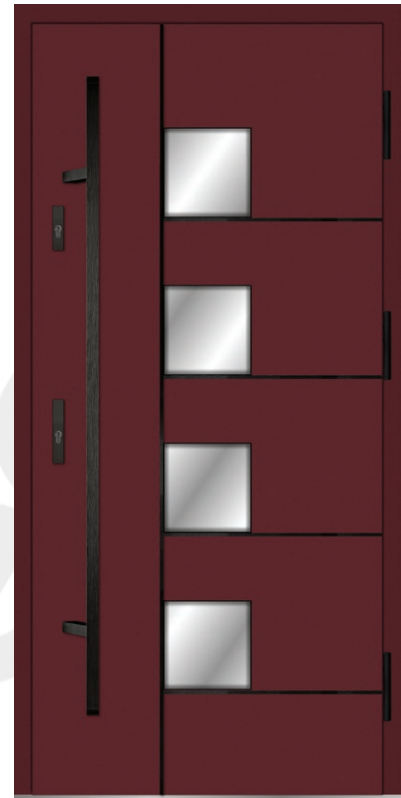

G 654/53

View from outside

View from inside



GL 614/48







GL 608/48



GL 616/49



GL 610/49



GL 612/50



GL 655/48



GL 656/49



GL 660/51



GL 662/53



# Modern Collection

The Modern collection includes modern designs with applications in brushed stainless steel or black. Doors from the collection are full of character. They show their nature in all their glory - the durability and nobility of metal. Great variety of designs allows you to match the model to any style of home.



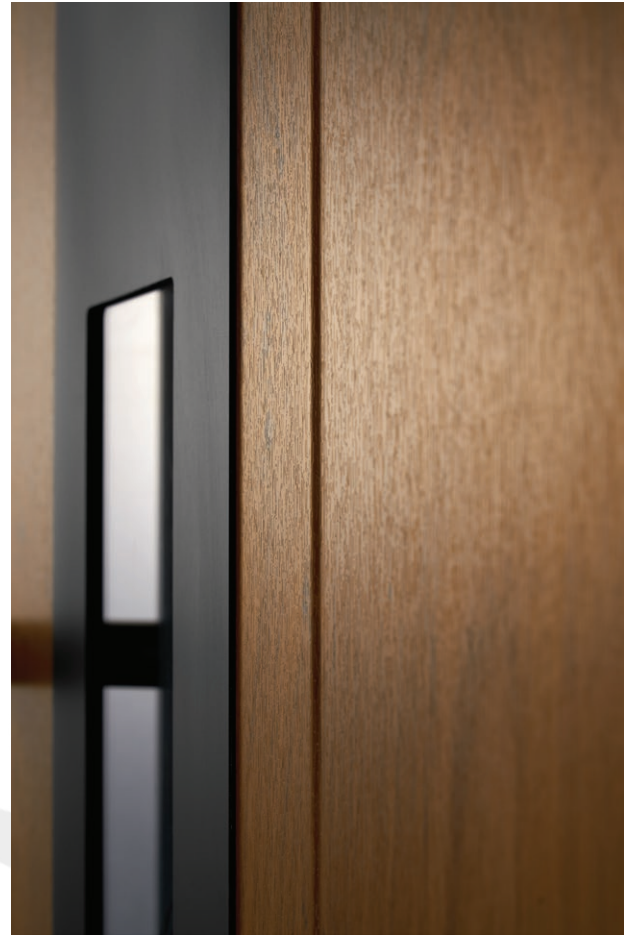

ALL DOORS AVAILABLE WITH BLACK OR BRUSHED STEEL GLASS FRAME



A 01/3



A 01/3



A 01/3



View from outside



View from inside



A 01/3

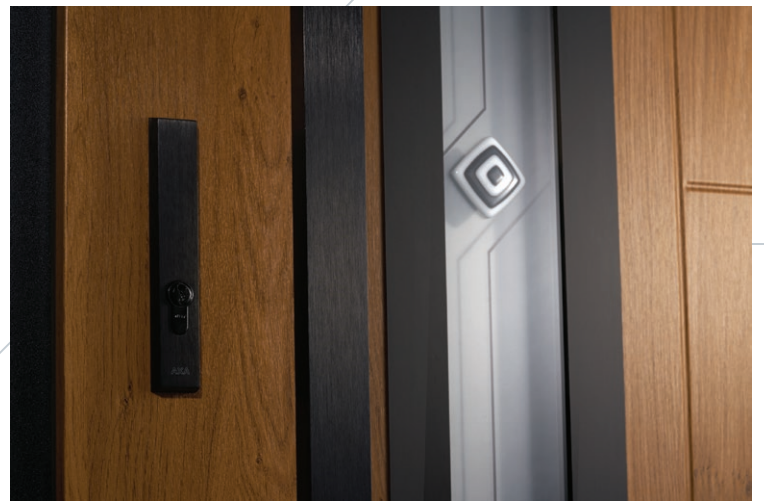





G 01/3



G 02/3



G 66/10



G 61/56



F 61/56



G 60/56



F 60/56

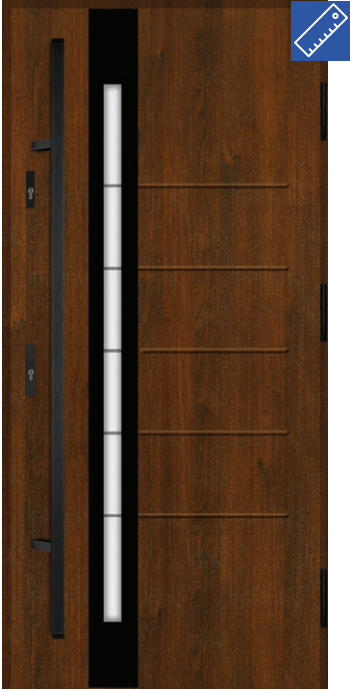

F 65/10



F 62/10



G 63/10



A 14/3



G 05/3



A 05/3



G 06/3

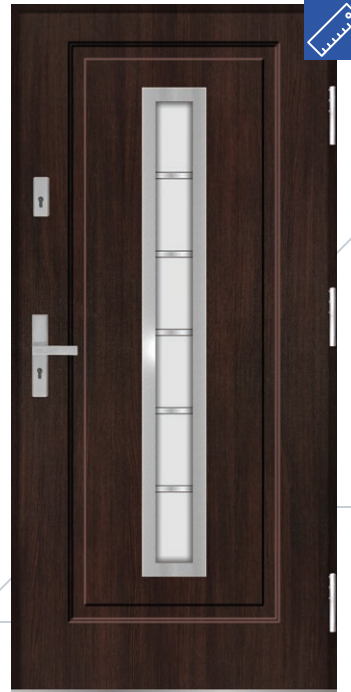

M 07/1





G 09/3



A 09/3



A 10/3



G 14/3



R 20/19



G 20/19



G 33/2



J 38/35



J 40/35



G 39/35



View from outside



View from inside



F 15/27





G 15/27



G 15/27



F 15/27

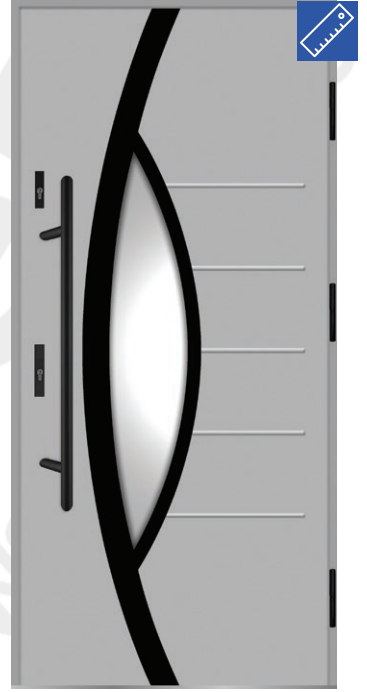

F 15/27



G 16/26

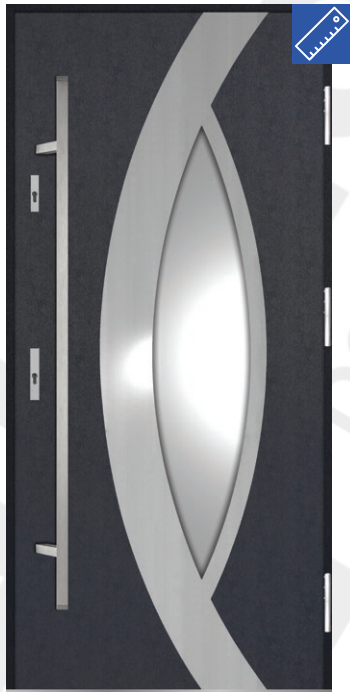

G 16/26



G 16/26

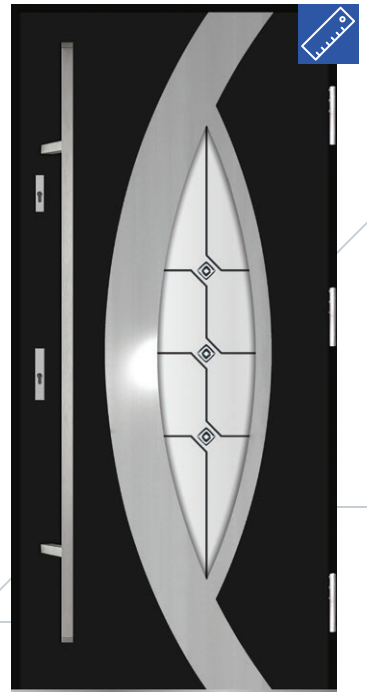

G 16/26





F 58/54



G 58/54



F 59/55



G 59/55



G 23/29



B 23/29



B 22/29

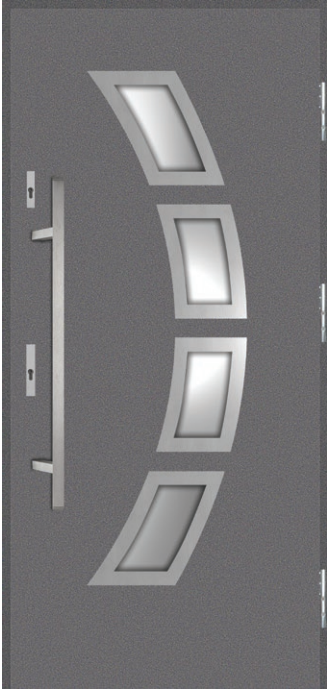

G 32/20



M 32/20



G 13/2



A 13/2



B 21/21



G 21/21



M 35/28



M 36/24





## No Glass Collection

Unglazed doors can also be an effective distinguishing feature of the house. Solid doors can have various embossing surface. Decorative applications can be made of sheet metal in natural, black or veneered colours. The use of visually attractive accessories such as bars and handles gives a lot of possibilities. In other collections you will also find unglazed doors, but this collection focuses solely on that solution.



G 00



G 00



G 00



G 00

View from outside

View from inside



G 00 + ALU 90







G 00



G 00

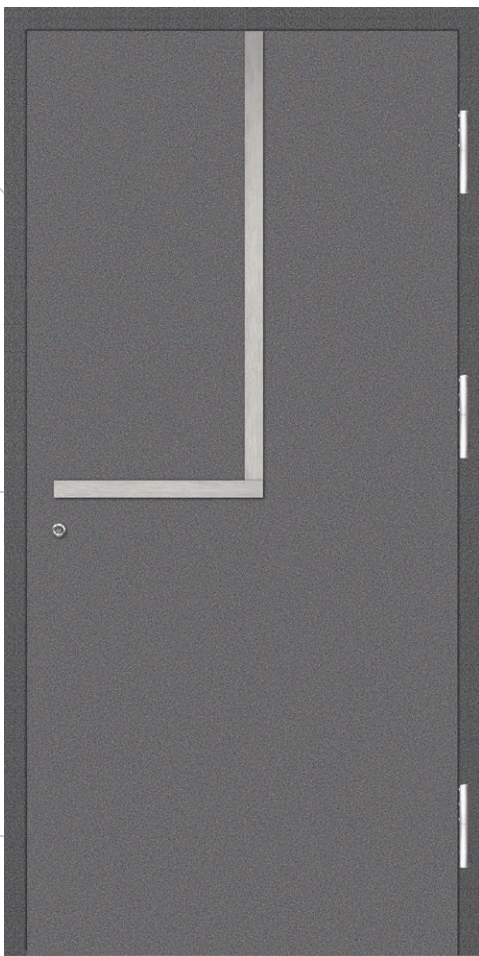
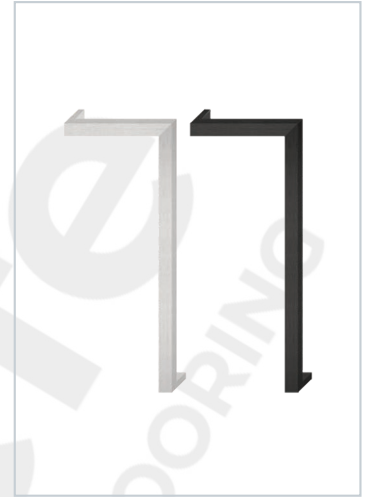

G 00

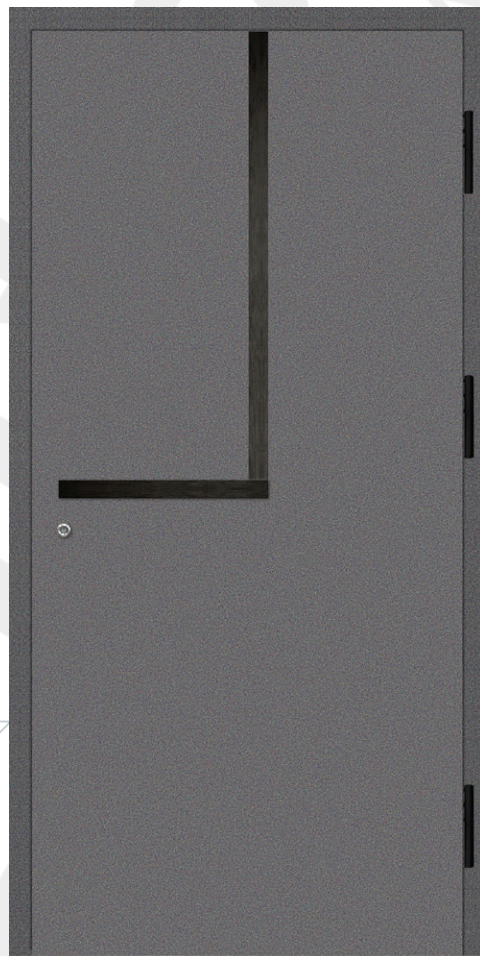

G 00





# Avant-garde, original handles

View from outside



View from inside

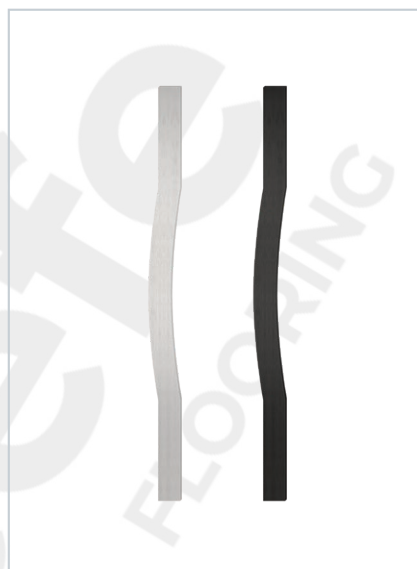

G 00 + DIAMOND SIDELIGHT







G 00 + ALU 90



G 00 + DIAMOND SIDELIGHT





G 00 + DIAMOND SIDELIGHT



G 00

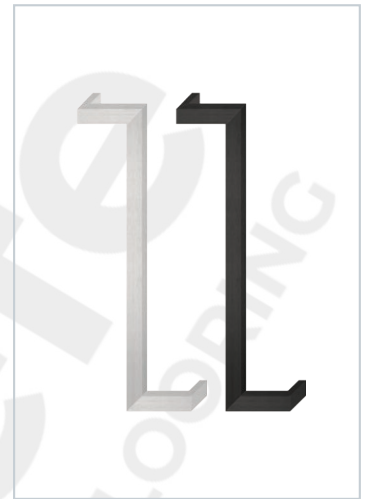

G 00 + ALU 90



G 00

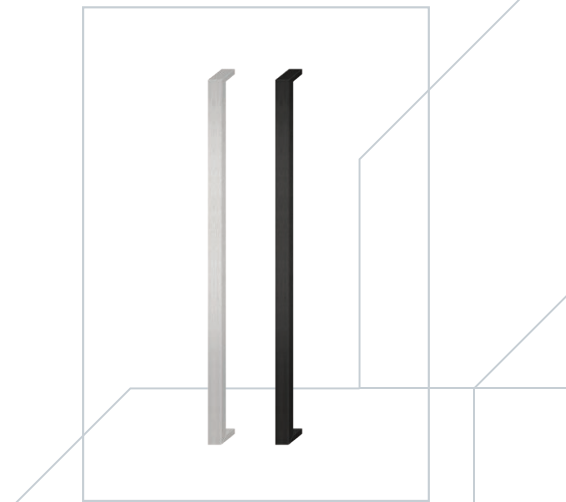





G 00 + DIAMOND SIDELIGHT

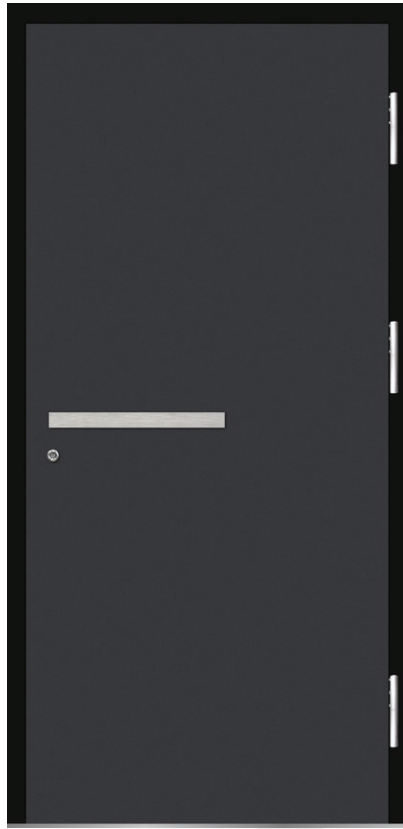

G 00



G 00 + DIAMOND SIDELIGHT



G 00





U 670



Q 669



Y 673



A 00



B 00



C 00





I 00



D 00



M 00



G 41



G 04



A 04

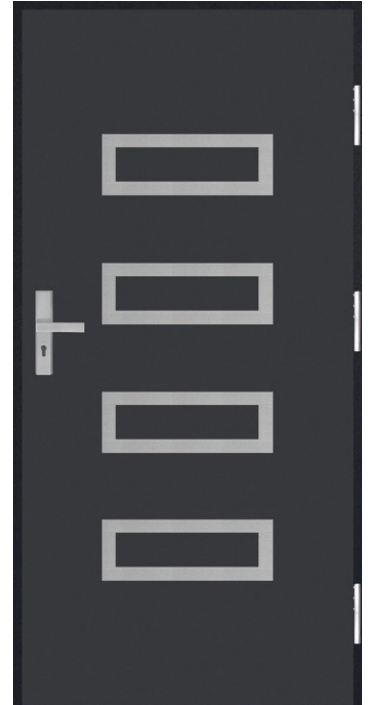

G 33

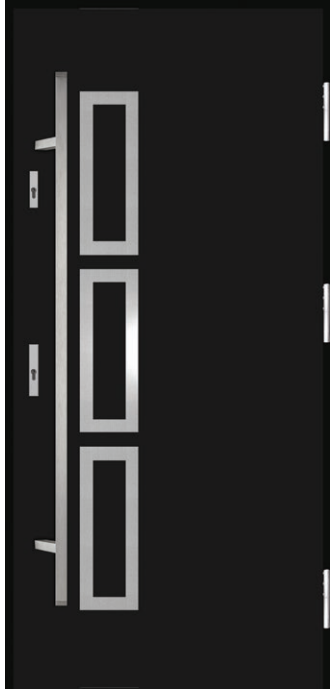

G 13



B 21



G 42



G 24



B 24



F 15





GL 53



GL 51



GL 55

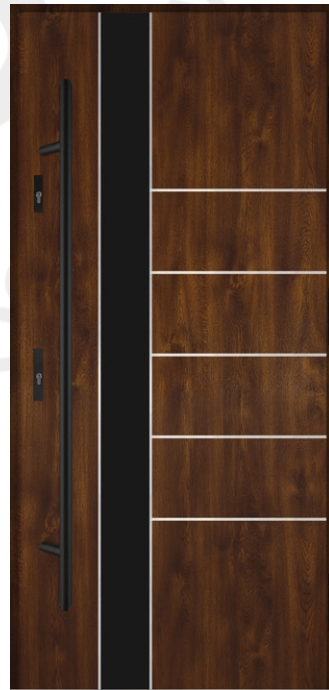

GL 56







# Standard door sizes

	DOOR SIZE	DOOR FRAME		OPENING		DOOR LEAF	
		HEIGHT $H_{C1}$	WIDTH $S_{C1}$	HEIGHT $H_b$	WIDTH $S_p$	HEIGHT $H_s$	WIDTH $S_s$
ARKTIC WOOD/STEEL	80	2096	911	2022	801	2051	850
	90	2096	1011	2022	901	2051	950
	90N	2070	970	1996	860	2025	909
	100	2096	1111	2022	1001	2051	909
ARKTIC ALU 90	80	2115	949	2022	801	2051	850
	90	2115	1079	2022	901	2051	950
	90N	2089	1008	1996	860	2025	909
	100	2115	1149	2022	1001	2051	1050

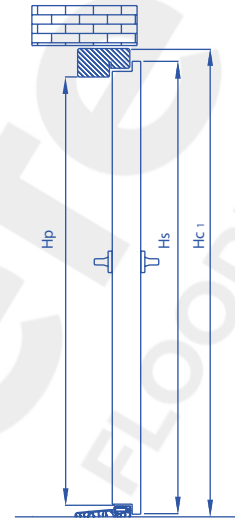

## Doors made to measure



All doors with that icon can be made to measure

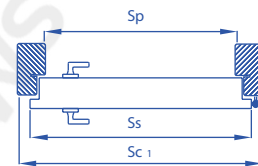

## ACCESORIES

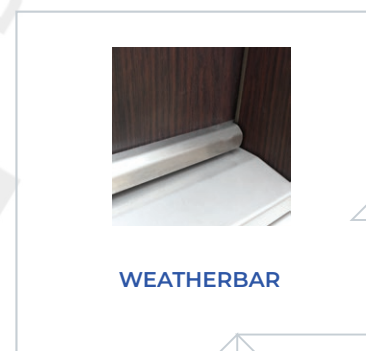



# Offset bar handles

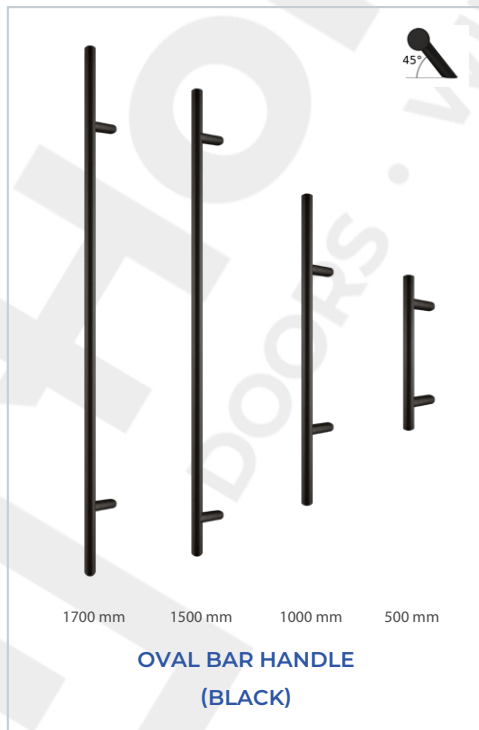
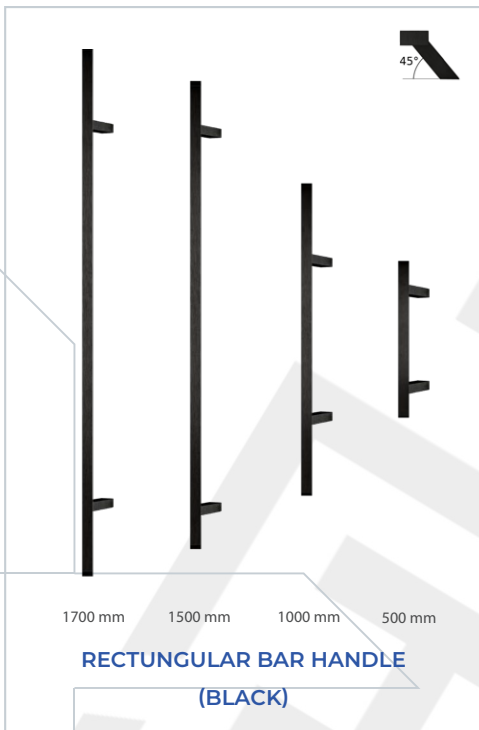
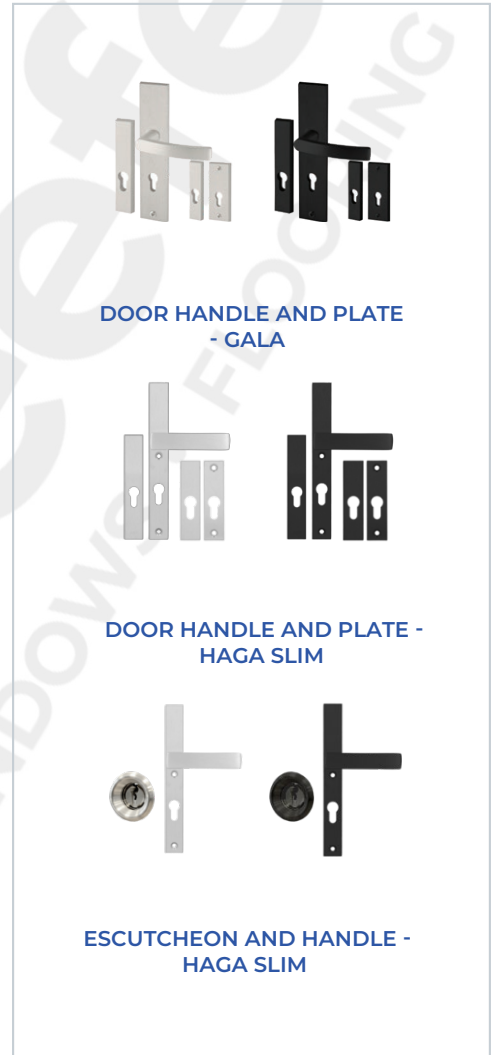
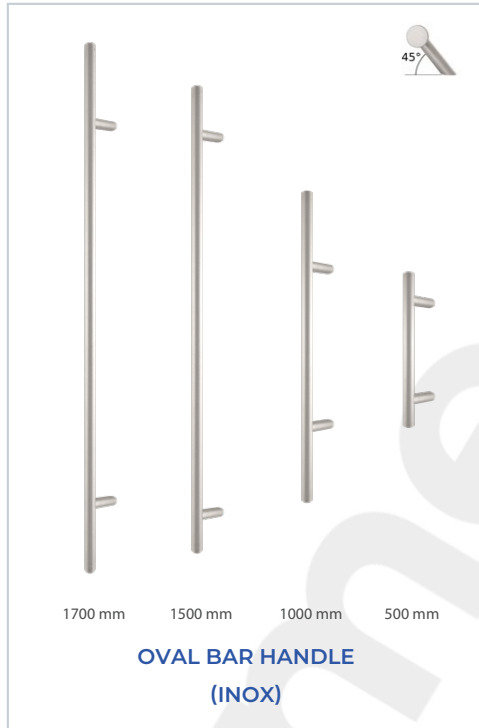
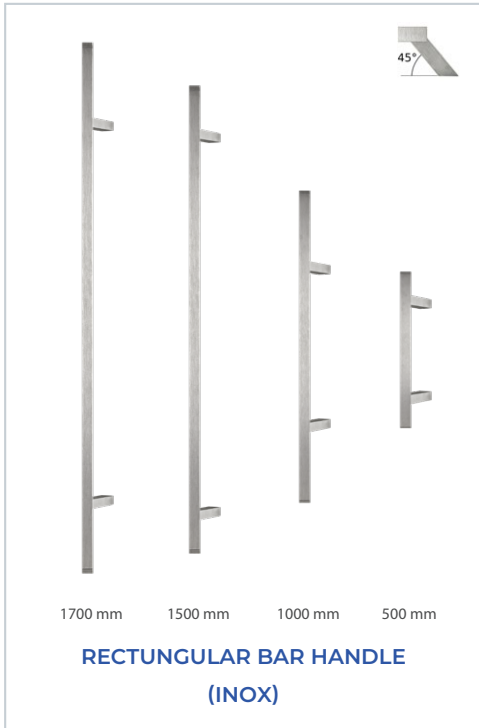

**NR 17** 2048 mm

GS 101/65  
- G 00

**NR 09** 1600 mm

GS 87/63  
- GS 90/63  
- 1KS 95/63  
- 1MS 96/63  
- 1NS 98/65  
- 1OS 99/66  
- GS 99/66  
- G 00

**NR 08** 1570 mm

GS 85/61  
- GS 86/62  
- G 00

**NR 14** 1000 mm

GB 92  
- G 00

**NR 18** 1400 mm

GS 84/60  
- GS 99/66  
- 1OS 99/66  
- GB 100/67  
- G 00

**NR 10** 300x830 mm

1IS 88/63  
- GS 88/63  
- G 00

**NR 12** 460x1038 mm

1JS 89/63  
- GS 89/63  
- G 00

**NR 13** 170x800x170 mm

GS 90/63  
- G 00

**NR 15** 830 mm

GB 93  
- G 00

**NR 11** 460 mm

GS 89/63  
- 1JS 89/63  
- GB 91  
- G 00

**NR 16** 165 mm

GB 94  
- G 00

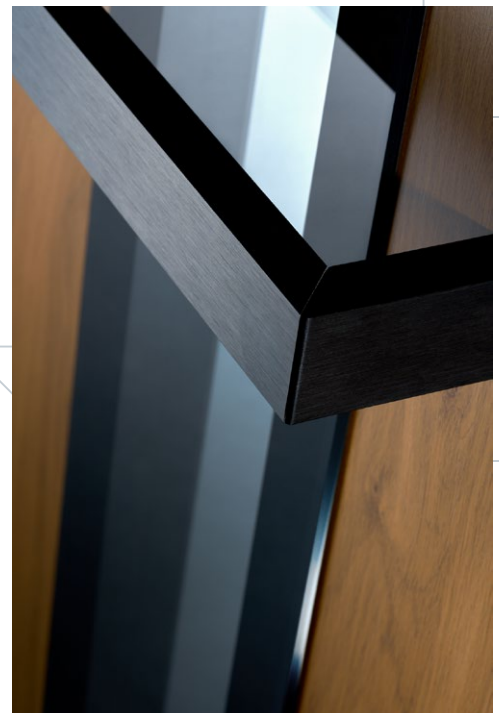



# ACCESORIES



CYLINDERS COMES IN 2 COLOUR OPTIONS

# AVAILABLE COLOURS

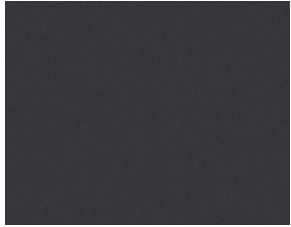

**ANTHRACITE**  
'orange skin' effect



**ANTHRACITE MOLET**  
wood effect

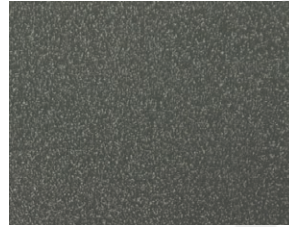

**ANTHRACITE QUARTZ**  
'orange skin' effect



**WHITE**  
wood effect

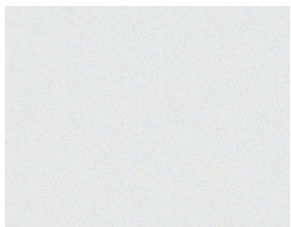

**WHITE STRUCTURE**  
'orange skin' effect

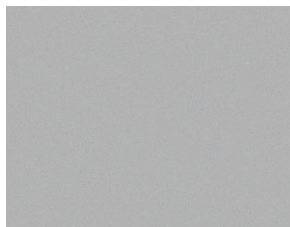

**GREY**  
wood effect

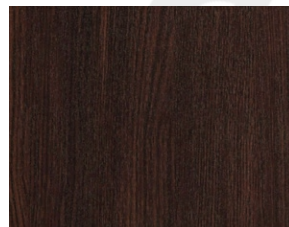

**WENGE**  
wood effect

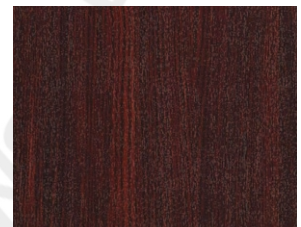

**ROSEWOOD**  
wood effect

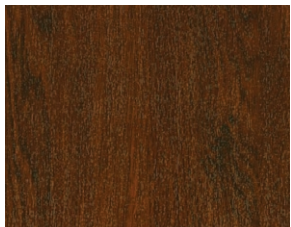

**BRAZILIAN OAK**  
wood effect

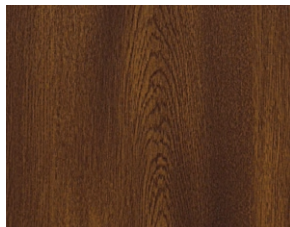

**WALNUT**  
wood effect

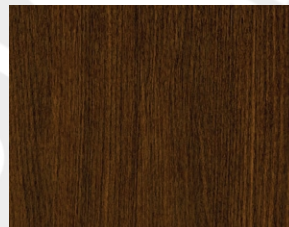

**DARK OAK**  
wood effect

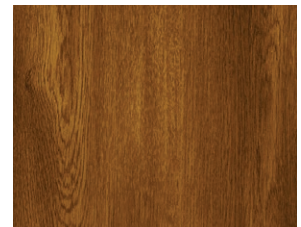

**GOLDEN OAK**  
wood effect

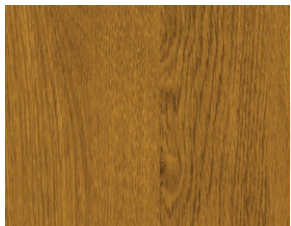

**WINCHESTER**  
wood effect

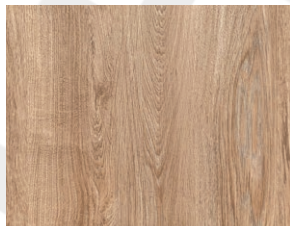

**OAK TURNER**  
wood effect

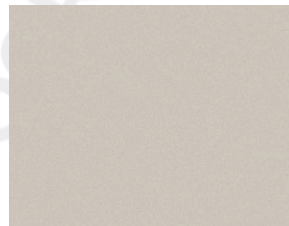

**CREAM**  
'orange skin' effect

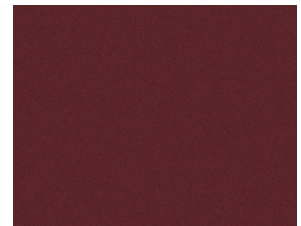

**BURGUNDY**  
'orange skin' effect

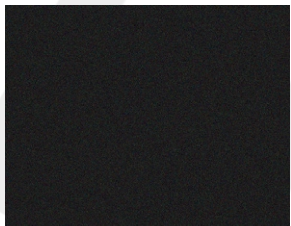

**BLACK**  
'orange skin' effect







**17 The Precinct  
High Street South  
Rushden, NN100QU**

**Call our Sales Advisors**

**T: 0 1933 413 817**

**T: 0 7483 391 546**

**E: [office@homeefe.co.uk](mailto:office@homeefe.co.uk)**

**[www.homeefe.co.uk](http://www.homeefe.co.uk)**



**Homeefe**  
DOORS · WINDOWS · FLOORING